



Your life. Our passion

---

**Kitchen  
Collection  
2016/17**



With Britannia, you always come home to quality. Our products help to make the kitchen the centre of the home, bringing families together through inspirational cooking. Britannia quality extends across the home to support every aspect of modern living with elegance and dependability.

While styles change over the years, our standards do not. We believe in design you can see, craftsmanship you can feel and reliability you can count on. Our latest collection embodies these values in appliances packed with features, designed to impress and built to last.



---

Oven functions & cooking features **4**

---

The Britannia range at a glance **6-7**

---

Delphi range **8-23**

---

Fleet range **24-35**

---

Q Line range **36-45**

---

Stanza range **46-51**

---

Colourange **52-53**

---

Cooker hoods **54-59**

---

Wall mounted hoods **56-58**

---

Canopy hoods **59**

---

Cooling **62-64**

---

Dishwasher **65**

---

Splashbacks & accessories **66-70**

---

Delivery & installation **71**

---

Hood ducting information **72-73**

---

Dimensions **74-75**

---

**britannia**

Your life. Our passion

# Britannia oven functions

Britannia's 90cm and 60cm ovens feature various functions, so you can use the most suitable cooking style for each recipe. By selecting different elements within the oven, you can ensure that the heat is directed to the required cooking area. Our 40cm and 30cm ovens also incorporate a rotisserie.\*

## NINE-FUNCTION OVEN



 Conventional cooking



 Bottom element only



 Top element only



 Fan-assisted oven



 True fan oven



 Pizza function

\*Rotisserie excluded: Delphi/Qline 90cm Single, Delphi Professional 60cm and Stanza Range cookers.

## Cooking features



 Traditional grilling



 Fan-assisted grilling



 Quickstart and defrost

FOUR-FUNCTION OVEN





The Britannia four-function oven has the following functions, plus a rotisserie.

  Rotisserie\*

**Note:** The maximum weight for the rotisserie is 3.5kg.

 **Quickstart**  
A fast preheat system to kickstart cooking.

 **Stainless steel griddle**  
Quick and healthy cooking option.

 **Meat probe**  
The perfect roast every time.

**9** **9 function electric oven**  
Packed with innovative features.

**8** **8 function electric oven**  
Packed with enhanced features.

**4** **4 function electric oven**  
Versatile cooking options.

 **Rotisserie**  
Spit-roasting for succulent results.

 **Grill elements in both ovens**  
Perfect for preparing multiple courses.

 **Fully automatic programmer**  
Lets you know the moment dinner's ready.

 **Adjustable grill**  
Stay in full control of your cooking.

 **5kW dual wok burner**  
High power, high performance burner.

Each cooking feature is explained in detail within the product section.

# The Britannia range at a glance



## Delphi See pages 8-23

Size	Colour	Hob Top
120cm	Black, Yellow, Red	Gas
110cm XG**	Black, Yellow, Red	Gas or Induction
100cm XG**	Black, Yellow, Red	Gas or Induction
100cm twin	Black, Yellow, Red	Gas or Induction
90cm twin	Black, Yellow, Red	Gas or Induction
90cm single	Black, Yellow, Red	Gas or Induction
60cm single*	Black, Yellow, Red	Gas or Induction

Features	
Gas hotplate	Single pressed hob
Flame failure devices	Yes
Cast iron pan supports	Yes
5kw dual wok burner	Yes*
Clock	Digital clock, minute minder and electronic programmer
Doors	Triple glazed
Stay-clean oven liners	Yes
Storage compartment	Soft close drawer*
Energy efficiency rating	A
Height adjustable legs	Yes
Meat probe	Yes*
Removable roof tray	Yes
Shelves included	Heavy duty oven shelves, one set of telescopic runners*

## Q Line See pages 36-45



Size	Colour	Hob Top
100cm XG**	Black, Yellow, Red	Gas or Induction
100cm twin	Black, Yellow, Red	Gas or Induction
90cm twin	Black, Yellow, Red	Gas or Induction
90cm single	Black, Yellow, Red	Gas or Induction

Features	
Gas hotplate	Single pressed hob
Flame failure devices	Yes
Cast iron pan supports	Yes
5kw dual wok burner	Yes*
Clock	Digital clock, minute minder and electronic programmer
Doors	Triple glazed
Stay-clean oven liners	Optional
Storage compartment	Yes
Energy efficiency rating	A
Height adjustable legs	Yes
Removable roof tray	Yes
Shelves included	Standard oven shelves



A truly unique Britannia oven can be yours with our colour matching service. See pages 52-53 for more details.

The Britannia range consists of four product families, offering different styles, features and benefits to suit the requirements of all cooking enthusiasts. This guide will assist you in making your selection. The chart highlights the colours and sizes available for each style.



## Fleet See pages 24-35

Size	Colour	Hob Top
120cm	Stainless steel, Gloss black, Gloss cream	Gas
110cm XG**	Stainless steel, Gloss black, Gloss cream	Gas or Induction
100cm XG**	Stainless steel, Gloss black, Gloss cream	Gas or Induction
100cm twin	Stainless steel, Gloss black, Gloss cream	Gas or Induction
90cm twin	Stainless steel, Gloss black, Gloss cream	Gas or Induction

### Features

Gas hotplate	Single pressed hob
Flame failure devices	Yes
Cast iron pan supports	Yes
5kw dual wok burner	Yes*
Clock	Digital clock, minute minder and electronic programmer
Doors	Triple glazed
Stay-clean oven liners	Yes
Storage compartment	Soft close drawer
Energy efficiency rating	A
Meat probe	Yes
Height adjustable legs	Yes
Removable roof tray	Yes
Shelves included	Heavy duty oven shelves, one set of telescopic runners



## Stanza See pages 46-51

Size	Colour	Hob Top
100cm twin	Gloss black, Stainless steel	Gas
90cm twin	Gloss black, Stainless steel	Gas

### Features

Gas hotplate	Single pressed hob
Flame failure devices	Yes
Cast iron pan supports	Yes
5kw dual wok burner	Yes*
Clock	Digital clock, minute minder and electronic programmer
Doors	Triple glazed
Stay-clean oven liners	Optional
Storage compartment	No
Energy efficiency rating	A
Height adjustable legs	Yes
Removable roof tray	Yes
Shelves included	Standard oven shelves

\*\*XG models are all fitted with leveling feet \*Model dependent

Colour options

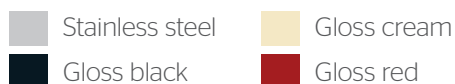

# Delphi





Beautifully encapsulating Britannia quality and innovation, it's easy to see why demand for the Delphi continues to grow. Combining sleek, modern looks with professional standard features, this flagship model's cutting edge design, reliability and ease of use make it the natural choice in any home.



# Delphi 120cm



RC-12TG-DE-S (544440313)



## Features

### Cooking

- QUICKSTART fast preheat system (both ovens)
- Electric stainless steel griddle
- Meat probe (left oven)
- 9 function electric ovens
- Grill elements in both ovens
- Fully automatic programmer and minute minder (left oven)
- 5kW dual wok burner

### Energy rating

- A-rated

### Safety

- Thermostatically controlled fan to prevent fascia from overheating
- Oven lights for good visibility
- Triple-glazed to prevent doors from overheating
- Flame failure devices to shut off gas supply

### Cleaning

- Removable oven door and inner glass panel
- Stay-clean liners for oven sides and back
- Removable enamelled roof trays
- Single piece pressed hob

### Other features

- Heavy duty shelves
- Wok support
- Soft close storage drawer
- Height adjustable legs
- One hand ignition
- Telescopic runners (left oven)

### Supplied with

#### Left oven

Two wire shelves, one grill pan with trivet and handle

#### Right oven

Two wire shelves, one grill pan with trivet

#### Stainless steel cover

For electric griddle

### Dimensions

#### Cooker

(W) 1195mm x (H) 890 - 915mm x (D) 600mm

#### Left oven internal

(W) 454mm x (H) 354mm x (D) 428mm  
(Gross: 69 litres, usable: 52 litres)

#### Right oven internal

(W) 454mm x (H) 354mm x (D) 428mm  
(Gross: 69 litres, usable: 52 litres)

## Optional accessories



Telescopic runners

- Cast iron griddle
- Splashback
- Plinth kit
- Telescopic runners

See pages 66-70 for more information

## Colour options

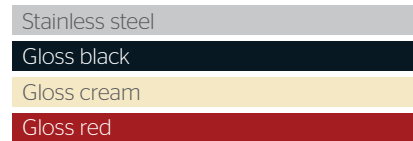

## Hob options



### Gas hotplate - six brass burners

One dual wok burner	0.48 - 5kW
One large burner	3kW
Three medium burners	1.75kW each
One small burner	1kW
One electric griddle	1kW

Convertible to LPG (bottled gas) if required

Dedicated cooker circuit with a 32 amp miniature circuit breaker

### Product codes

Stainless steel	RC-12TG-DE-S (544440313)
Gloss black	RC-12TG-DE-K (544440332)
Gloss cream	RC-12TG-DE-CR (544440746)
Gloss red	RC-12TG-DE-RED (544440340)

## Recommended hood



### Arioso

Available in matching colour

See pages 54-59 for more information

# Delphi 110cm XG



RC-11XGG-DE-K (544440123)



## Features

### Cooking

- QUICKSTART fast preheat system (left oven)
- Meat probe (left oven)
- 9 function (left) electric oven
- 4 function (right) electric oven
- Rotisserie for spit-roasting (right oven)
- Grill elements in both ovens
- Powerful adjustable grill in separate compartment
- Fully automatic programmer and minute minder (left oven)
- 2 x 5kW dual wok burners\*

### Energy rating

- A-rated

### Safety

- Thermostatically controlled fan to prevent fascia from overheating
- Oven lights for good visibility
- Triple-glazed to prevent doors from overheating
- Flame failure device to shut off gas supply\*

### Cleaning

- Removable oven door and inner glass panel
- Stay-clean liners for oven sides and back (left oven)
- Stay-clean liners for oven sides (right oven)
- Removable enamelled roof trays
- Single piece pressed hob

### Other features

- Heavy duty shelves
- Wok support\*
- Soft close storage drawer
- Leveling feet
- One hand ignition
- Telescopic runners (left oven + grill compartment)

### Supplied with

#### Left oven

Two wire shelves, one grill pan with trivet and handle

#### Right oven

One wire shelf, one grill pan with trivet, rotisserie

#### Grill compartment

Full sized roll-out grill pan with trivet

### Dimensions

#### Cooker

(W) 1095mm x (H) 910 - 915mm x (D) 600mm

#### Left oven internal

(W) 454mm x (H) 354mm x (D) 428mm  
(Gross: 69 litres, usable: 52 litres)

#### Right oven internal

(W) 354mm x (H) 354mm x (D) 428mm  
(Gross: 54 litres, usable: 42 litres)

## Optional accessories



- Chef Top\*
- Cast iron griddle\*
- Splashback
- Telescopic runners

See pages 66-70 for more information

## Colour options

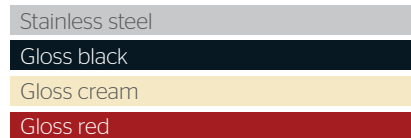

## Hob options

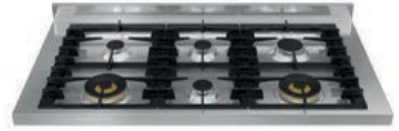

### Gas hotplate - six brass burners

Two dual wok burners	0.48 - 5kW each
One large burner	3kW
Three medium burners	1.75kW each

Convertible to LPG (bottled gas) if required  
Dedicated cooker circuit with a 32 amp miniature circuit breaker

### Product codes

Stainless steel	RC-11XGG-DE-S (544440013)
Gloss black	RC-11XGG-DE-K (544440123)
Gloss cream	RC-11XGG-DE-CR (544440613)
Gloss red	RC-11XGG-DE-RED (544440324)



### Induction - 5 zones

Front left zone	1100/1400 watts
Back left zone	1400/2000 watts
Central zone	2300/3000 watts
Front right zone	1100/1400 watts
Back right zone	2300/3000 watts

Dedicated cooker circuit with a 40 amp miniature circuit breaker

### Product codes

Stainless steel	RC-11XGI-DE-S (544440248)
Gloss black	RC-11XGI-DE-K (544440247)
Gloss cream	RC-11XGI-DE-CR (544440372)
Gloss red	RC-11XGI-DE-RED (544440370)

## Recommended hood



### Arioso

Available in matching colour  
See pages 54-59 for more information

\*Gas hob only

# Delphi 100cm XG



RC-10XGI-DE-RED (544440014)



## Features

### Cooking

- QUICKSTART fast preheat system (left oven)
- Meat probe (left oven)
- 9 function (left) electric oven
- 4 function (right) electric oven
- Rotisserie for spit-roasting (right oven)
- Grill elements in both ovens
- Powerful adjustable grill in separate compartment
- Fully automatic programmer and minute minder (left oven)
- 2 x 5kW dual wok burners\*

### Energy rating

- A-rated

### Safety

- Thermostatically controlled fan to prevent fascia from overheating
- Oven lights for good visibility
- Triple-glazed to prevent doors from overheating
- Flame failure devices to shut off gas supply\*

### Cleaning

- Removable oven door and inner glass panel
- Stay-clean liners for oven sides and back (left oven)
- Stay-clean liners for oven sides (right oven)
- Removable enamelled roof trays
- Single piece pressed hob

### Other features

- Heavy duty shelves
- Wok support\*
- Soft close storage drawer
- Leveling feet
- One hand ignition
- Telescopic runners (left oven + grill compartment)

### Supplied with

#### Left oven

Two wire shelves, one grill pan with trivet and handle

#### Right oven

One wire shelf, one grill pan with trivet, rotisserie

#### Grill compartment

Full sized roll-out grill pan with trivet

### Dimensions

#### Cooker

(W) 995mm x (H) 910 - 915mm x (D) 600mm

#### Left oven internal

(W) 454mm x (H) 354mm x (D) 428mm  
(Gross: 69 litres, usable: 52 litres)

#### Right oven internal

(W) 354mm x (H) 354mm x (D) 428mm  
(Gross: 54 litres, usable: 42 litres)

## Optional accessories



Cast iron griddle

- Chef Top\*
- Cast iron griddle\*
- Splashback
- Telescopic runners

See pages 66-70 for more information

## Colour options

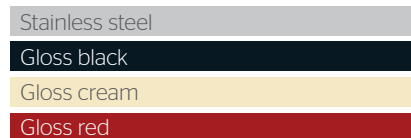

## Hob options

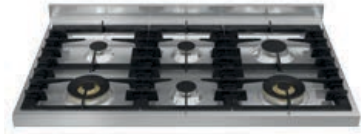

### Gas hotplate - six brass burners

Two dual wok burners 0.48 - 5kW each

One large burner 3kW

Three medium burners 1.75kW each

Convertible to LPG (bottled gas) if required

Dedicated cooker circuit with a 32 amp miniature circuit breaker

### Product codes

Stainless steel RC-10XGG-DE-S (544440125)

Gloss black RC-10XGG-DE-K (544440232)

Gloss cream RC-10XGG-DE-CR (544440325)

Gloss red RC-10XGG-DE-RED (544440267)



### Induction - 5 zones

Front left zone 1100/1400 watts

Back left zone 1400/2000 watts

Central zone 2300/3000 watts

Front right zone 1100/1400 watts

Back right zone 2300/3000 watts

Dedicated cooker circuit with a 40 amp miniature circuit breaker

### Product codes

Stainless steel RC-10XGI-DE-S (544440192)

Gloss black RC-10XGI-DE-K (544440203)

Gloss cream RC-10XGI-DE-CR (544440235)

Gloss red RC-10XGI-DE-RED (544440014)

## Recommended hood



### Arioso

Available in matching colour

See pages 54-59 for more information

\*Gas hob only

# Delphi 100cm twin



RC-10TG-DE-S (544440112)





## Features

### Cooking

- QUICKSTART fast preheat system (left oven)
- Meat probe (left oven)
- 9 function (left) electric oven
- 4 function (right) electric oven
- Rotisserie for spit-roasting (right oven)
- Grill elements in both ovens
- Fully automatic programmer and minute minder (left oven)
- 2 x 5kW dual wok burners\*

### Energy rating

- A-rated

### Safety

- Thermostatically controlled fan to prevent fascia from overheating
- Oven lights for good visibility
- Triple-glazed to prevent doors from overheating
- Flame failure devices to shut off gas supply\*

### Cleaning

- Removable oven door and inner glass panel
- Stay-clean liners for oven sides and back (left oven)
- Stay-clean liners for oven sides (right oven)
- Removable enamelled roof trays
- Single piece pressed hob

### Other features

- Heavy duty shelves
- Wok support\*
- Soft close storage drawer
- Height adjustable legs
- One hand ignition
- Telescopic runners (left oven)

### Supplied with

#### Left oven

Two wire shelves, one grill pan with trivet and handle

#### Right oven

One wire shelf, one grill pan with trivet, rotisserie

### Dimensions

#### Cooker

(W) 995mm x (H) 890 - 915mm x (D) 600mm

#### Left oven internal

(W) 454mm x (H) 354mm x (D) 428mm  
(Gross: 69 litres, usable: 52 litres)

#### Right oven internal

(W) 354mm x (H) 354mm x (D) 428mm  
(Gross: 54 litres, usable: 42 litres)

## Optional accessories



Decorative stainless steel splashbacks

- Chef Top\*
- Cast iron griddle\*
- Splashback
- Plinth kit
- Telescopic runners

See pages 66-70 for more information

## Colour options

Stainless steel

Gloss black

Gloss cream

Gloss red

## Hob options

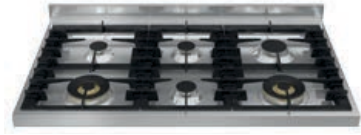

### Gas hotplate - six brass burners

Two dual wok burners 0.48 - 5kW each

One large burner 3kW

Three medium burners 1.75kW each

Convertible to LPG (bottled gas) if required

Dedicated cooker circuit with a 20 amp miniature circuit breaker

### Product codes

Stainless steel RC-10TG-DE-S (544440112)

Gloss black RC-10TG-DE-K (544440086)

Gloss cream RC-10TG-DE-CR (544440175)

Gloss red RC-10TG-DE-RED (544440026)



### Induction - 5 zones

Front left zone 1100/1400 watts

Back left zone 1400/2000 watts

Central zone 2300/3000 watts

Front right zone 1100/1400 watts

Back right zone 2300/3000 watts

Dedicated cooker circuit with a 32/40 amp miniature circuit breaker

### Product codes

Stainless steel RC-10TI-DE-S (544440148)

Gloss black RC-10TI-DE-K (544440250)

Gloss cream RC-10TI-DE-CR (544440776)

Gloss red RC-10TI-DE-RED (544440236)

## Recommended hood



### Brioso

Available in stainless steel

See pages 54-59 for more information

\*Gas hob only

# Delphi 90cm twin



RC-9TI-DE-K (544440062)



## Features

### Cooking

- QUICKSTART fast preheat system (left oven)
- Meat probe (left oven)
- 9 function (left) electric oven
- 4 function (right) electric oven
- Rotisserie for spit-roasting (right oven)
- Grill elements in both ovens
- Fully automatic programmer and minute minder (left oven)
- 5kW dual wok burner\*

### Energy rating

- A-rated

### Safety

- Thermostatically controlled fan to prevent fascia from overheating
- Oven lights for good visibility
- Triple-glazed to prevent doors from overheating
- Flame failure devices to shut off gas supply\*

### Cleaning

- Removable oven door and inner glass panel
- Stay-clean liners for oven sides and back (left oven)
- Stay-clean liners for oven sides (right oven)
- Removable enamelled roof trays
- Single piece pressed hob

### Other features

- Heavy duty shelves
- Wok support\*
- Soft close storage drawer
- Height adjustable legs
- One hand ignition
- Telescopic runners (left oven)

### Supplied with

#### Left oven

Two wire shelves, one grill pan with trivet and handle

#### Right oven

One wire shelf, one grill pan with trivet, rotisserie

### Dimensions

#### Cooker

(W) 895mm x (H) 890 - 915mm x (D) 600mm

#### Left oven internal

(W) 454mm x (H) 354mm x (D) 428mm  
(Gross: 69 litres, usable: 52 litres)

#### Right oven internal

(W) 254mm x (H) 354mm x (D) 428mm  
(Gross: 38 litres, usable: 28 litres)

## Optional accessories



Plinth kit

- Chef Top\*
- Cast iron griddle\*
- Splashback
- Plinth kit
- Telescopic runners

See pages 66-70 for more information

## Colour options



## Hob options



### Gas hotplate - six brass burners

One dual wok burner	0.48 - 5kW
One large burner	3kW
Three medium burners	1.75kW each
One small burner	1kW

Convertible to LPG (bottled gas) if required  
Dedicated cooker circuit with a 20 amp miniature circuit breaker

### Product codes

Stainless steel	RC-9TG-DE-S (544440156)
Gloss black	RC-9TG-DE-K (544440246)
Gloss cream	RC-9TG-DE-CR (544440316)
Gloss red	RC-9TG-DE-RED (544440234)



### Induction - 5 zones

Front left zone	1100/1400 watts
Back left zone	1400/2000 watts
Central zone	2300/3000 watts
Front right zone	1100/1400 watts
Back right zone	2300/3000 watts

Dedicated cooker circuit with a 32/40 amp miniature circuit breaker

### Product codes

Stainless steel	RC-9TI-DE-S (544440155)
Gloss black	RC-9TI-DE-K (544440062)
Gloss cream	RC-9TI-DE-CR (544440751)
Gloss red	RC-9TI-DE-RED (544440748)

## Recommended hood



### Omaggio

Available in black glass with stainless steel  
See pages 54-59 for more information

\*Gas hob only

# Delphi 90cm single



RC-9SG-DE-CR (544440270)



## Features

### Cooking

- QUICKSTART fast preheat system
- Meat probe
- 9 function electric oven
- Grill element in oven
- Fully automatic programmer and minute minder
- 5kW dual wok burner

### Energy rating

- A-rated

### Safety

- Thermostatically controlled fan to prevent fascia from overheating
- Oven lights for good visibility
- Triple-glazed to prevent door from overheating
- Flame failure devices to shut off gas supply\*

### Cleaning

- Removable oven door and inner glass panel
- Stay-clean liners for oven sides and back
- Removable enamelled roof tray
- Single piece pressed hob

### Other features

- Heavy duty shelves
- Wok support\*
- Soft close storage drawer
- Height adjustable legs
- One hand ignition
- Telescopic runners

### Supplied with

**Oven**  
Two wire shelves, one grill pan with trivet and handle

### Dimensions

**Cooker**  
(W) 895mm x (H) 870 - 910mm x (D) 600mm

**Oven internal**  
(W) 678mm x (H) 354mm x (D) 428mm  
(Gross: 103 litres, usable: 80 litres)

## Optional accessories



- Chef Top\*
- Cast iron griddle\*
- Splashback
- Plinth kit
- Telescopic runners

See pages 66-70 for more information

## Colour options

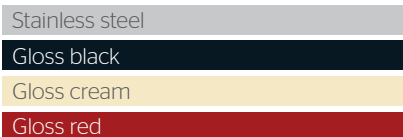

## Hob options



### Gas hotplate - six brass burners

One dual wok burner	0.48 - 5kW
One large burner	3kW
Three medium burners	1.75kW each
One small burner	1kW

Convertible to LPG (bottled gas) if required  
Dedicated cooker circuit with a 20 amp miniature circuit breaker

### Product codes

Stainless steel	RC-9SG-DE-S (544440211)
Gloss black	RC-9SG-DE-K (544440615)
Gloss cream	RC-9SG-DE-CR (544440270)
Gloss red	RC-9SG-DE-RED (544440813)



### Induction - 5 zones

Front left zone	1100/1400 watts
Back left zone	1400/2000 watts
Central zone	2300/3000 watts
Front right zone	1100/1400 watts
Back right zone	2300/3000 watts

Dedicated cooker circuit with a 32/40 amp miniature circuit breaker

### Product codes

Stainless steel	RC-9SI-DE-S (544440752)
Gloss black	RC-9SI-DE-K (544440896)
Gloss cream	RC-9SI-DE-CR (544440895)
Gloss red	RC-9SI-DE-RED (544440897)

## Recommended hood



### Ariosso

Available in matching colour  
See pages 54-59 for more information

\*Gas hob only

# Delphi Professional 60cm single



RC-6SG-DE-S (544446301)



RC-6SI-DE-S (544446302)



## Features

### Cooking

- 8 multifunction electric oven
- Grill element in oven
- LED fully automatic programmer
- 4kW wok burner

### Energy rating

- A-rated

### Safety

- Thermostatically controlled fan to prevent fascia from overheating\*\*
- Oven light for good visibility
- Triple-glazed to prevent door from overheating
- Flame failure devices to shut off gas supply\*

### Cleaning

- Removable inner glass panel
- Single piece pressed hob

### Other features

- Heavy duty shelves
- Wok support\*
- Push/Pull storage drawer
- Height adjustable feet
- One hand ignition
- Telescopic runners

## Optional accessories



- Cast iron griddle\*

See pages 66-70 for more information

### Supplied with

#### Oven

One shelf and one grill pan with trivet and handle

### Dimensions

#### Cooker

(W) 600mm x (H) 890mm x (D) 600mm

#### Oven internal

(W) 435mm x (H) 335mm x (D) 425mm  
(Gross: 62 litres, usable: 55 litres)

## Colour options

Stainless steel

## Hob options



### Gas hotplate - four brass burners

One wok burner	4kW
Two medium burners	1.75kW each
One small burner	1kW

Convertible to LPG (bottled gas) if required

### Product codes

Stainless steel RC-6SG-DE-S (544446301)



### Induction - 4 zones

Front left zone	1500/2000 watts
Back left zone	1200/1600 watts
Front right zone	1200/1600 watts
Back right zone	1500/2000 watts

### Product codes

Stainless steel RC-6SI-DE-S (544446302)

\*Gas hob only

# Fleet





Country kitchen style that looks at home anywhere, reap the benefits of the Fleet's professional functionality, with features such as heavy duty shelves, telescopic runners and soft close drawers. Curved windows and a gloss finish give a traditional feel, yet the Fleet is everything the modern kitchen demands.



# Fleet 120cm



RC-12TG-FL-S (544446260)



## Features

### Cooking

- QUICKSTART fast preheat system (both ovens)
- Electric stainless steel griddle
- Meat probe (left oven)
- 9 function electric ovens
- Grill elements in both ovens
- Fully automatic programmer and minute minder (left oven)
- 5kW dual wok burner

### Energy rating

- A-rated

### Safety

- Thermostatically controlled fan to prevent fascia from overheating
- Oven lights for good visibility
- Triple-glazed to prevent doors from overheating
- Flame failure devices to shut off gas supply

### Cleaning

- Removable oven door and inner glass panel
- Stay-clean liners for oven sides and back
- Removable enamelled roof trays
- Single piece pressed hob

### Other features

- Heavy duty shelves
- Wok support
- Soft close storage drawer
- Height adjustable legs
- One hand ignition
- Telescopic runners (left oven)

### Supplied with

#### Left oven

Two wire shelves, one grill pan with trivet and handle

#### Right oven

Two wire shelves, one grill pan with trivet

#### Stainless steel cover

For electric griddle

### Dimensions

#### Cooker

(W) 1195mm x (H) 890 - 915mm x (D) 600mm

#### Left oven internal

(W) 454mm x (H) 354mm x (D) 428mm  
(Gross: 69 litres, usable: 52 litres)

#### Right oven internal

(W) 454mm x (H) 354mm x (D) 428mm  
(Gross: 69 litres, usable: 52 litres)

## Optional accessories



Cast iron griddle

- Chef Top
- Cast iron griddle
- Splashback
- Plinth kit
- Telescopic runners

See pages 66-70 for more information

## Colour options



## Hob options



### Gas hotplate - six brass burners

One dual wok burner	0.48 - 5kW
One large burner	3kW
Three medium burners	1.75kW each
One small burner	1kW
One electric griddle	1kW

Convertible to LPG (bottled gas) if required

Dedicated cooker circuit with a 32 amp miniature circuit breaker

### Product codes

Gloss black	RC-12TG-FL-K (544446262)
Gloss cream	RC-12TG-FL-CR (544446261)
Stainless steel	RC-12TG-FL-S (544446260)

## Recommended hood



### Latour

Available in stainless steel

See pages 54-59 for more information

# Fleet 110cm XG



RC-1IXGG-FL-CR (544446264)



## Features

### Cooking

- QUICKSTART fast preheat system (left oven)
- Meat probe (left oven)
- 9 function (left) electric oven
- 4 function (right) electric oven
- Rotisserie for spit-roasting (right oven)
- Grill elements in both ovens
- Powerful adjustable grill in separate compartment
- Fully automatic programmer and minute minder (left oven)
- 2 x 5kW dual wok burners\*

### Energy rating

- A-rated

### Safety

- Thermostatically controlled fan to prevent fascia from overheating
- Oven lights for good visibility
- Triple-glazed to prevent doors from overheating
- Flame failure devices to shut off gas supply\*

### Cleaning

- Removable oven door and inner glass panel
- Stay-clean liners for oven sides and back (left oven)
- Stay-clean liners for oven sides (right oven)
- Removable enamelled roof trays
- Single piece pressed hob

### Other features

- Heavy duty shelves
- Wok support\*
- Soft close storage drawer
- Leveling feet
- One hand ignition
- Telescopic runners (left oven + grill compartment)

### Supplied with

#### Left oven

Two wire shelves, one grill pan with trivet and handle

#### Right oven

One wire shelf, one grill pan with trivet, rotisserie

#### Grill compartment

Full sized roll-out grill pan with trivet

### Dimensions

#### Cooker

(W) 1095mm x (H) 910 - 915mm x (D) 600mm

#### Left oven internal

(W) 454mm x (H) 354mm x (D) 428mm  
(Gross: 69 litres, usable: 52 litres)

#### Right oven internal

(W) 354mm x (H) 354mm x (D) 428mm  
(Gross: 54 litres, usable: 42 litres)

## Optional accessories



- Chef Top\*
- Cast iron griddle\*
- Splashback
- Telescopic runners

See pages 66-70 for more information

## Colour options



## Hob options

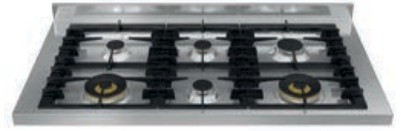

### Gas hotplate - six brass burners

Two dual wok burners 0.48 - 5kW each

One large burner 3kW

Three medium burners 1.75kW each

Convertible to LPG (bottled gas) if required

Dedicated cooker circuit with a 32 amp miniature circuit breaker

### Product codes

Gloss black RC-11XGG-FL-K (544446265)

Gloss cream RC-11XGG-FL-CR (544446264)

Stainless steel RC-11XGG-FL-S (544446263)



### Induction - 5 zones

Front left zone 1100/1400 watts

Back left zone 1400/2000 watts

Central zone 2300/3000 watts

Front right zone 1100/1400 watts

Back right zone 2300/3000 watts

Dedicated cooker circuit with a 40 amp miniature circuit breaker

### Product codes

Gloss black RC-11XGI-FL-K (544446268)

Gloss cream RC-11XGI-FL-CR (544446267)

Stainless steel RC-11XGI-FL-S (544446266)

## Recommended hood



### Latour (2tone)

Available in matching colour

See pages 54-59 for more information

\*Gas hob only

# Fleet 100cm XG



RC-10XGI-FL-K (544446274)



## Features

### Cooking

- QUICKSTART fast preheat system (left oven)
- Meat probe (left oven)
- 9 function (left) electric oven
- 4 function (right) electric oven
- Rotisserie for spit-roasting (right oven)
- Grill elements in both ovens
- Powerful adjustable grill in separate compartment
- Fully automatic programmer and minute minder (left oven)
- 2 x 5kW dual wok burners\*

### Energy rating

- A-rated

### Safety

- Thermostatically controlled fan to prevent fascia from overheating
- Oven lights for good visibility
- Triple-glazed to prevent doors from overheating
- Flame failure devices to shut off gas supply\*

### Cleaning

- Removable oven door and inner glass panel
- Stay-clean liners for oven sides and back (left oven)
- Stay-clean liners for oven sides (right oven)
- Removable enamelled roof trays
- Single piece pressed hob

### Other features

- Heavy duty shelves
- Wok support\*
- Soft close storage drawer
- Leveling feet
- One hand ignition
- Telescopic runners (left oven + grill compartment)

### Supplied with

#### Left oven

Two wire shelves, one grill pan with trivet and handle

#### Right oven

One wire shelf, one grill pan with trivet, rotisserie

#### Grill compartment

Full sized roll-out grill pan with trivet

### Dimensions

#### Cooker

(W) 995mm x (H) 910 - 915mm x (D) 600mm

#### Left oven internal

(W) 454mm x (H) 354mm x (D) 428mm  
(Gross: 69 litres, usable: 52 litres)

#### Right oven internal

(W) 354mm x (H) 354mm x (D) 428mm  
(Gross: 54 litres, usable: 42 litres)

## Optional accessories



Telescopic runners

- Chef Top\*
- Cast iron griddle\*
- Splashback
- Telescopic runners

See pages 66-70 for more information

## Colour options



## Hob options

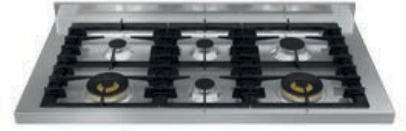

### Gas hotplate - six brass burners

Two dual wok burners 0.48 - 5kW each

One large burner 3kW

Three medium burners 1.75kW each

Convertible to LPG (bottled gas) if required

Dedicated cooker circuit with a 32 amp miniature circuit breaker

### Product codes

Gloss black RC-10XGG-FL-K (544446271)

Gloss cream RC-10XGG-FL-CR (544446270)

Stainless steel RC-10XGG-FL-S (544446269)



### Induction - 5 zones

Front left zone 1100/1400 watts

Back left zone 1400/2000 watts

Central zone 2300/3000 watts

Front right zone 1100/1400 watts

Back right zone 2300/3000 watts

Dedicated cooker circuit with a 40 amp miniature circuit breaker

### Product codes

Gloss black RC-10XGI-FL-K (544446274)

Gloss cream RC-10XGI-FL-CR (544446273)

Stainless steel RC-10XGI-FL-S (544446272)

## Recommended hood



### Latour (2tone)

Available in matching colour

See pages 54-59 for more information

\*Gas hob only

# Fleet 100cm twin



RC-10TG-FL-S (544446275)





## Features

### Cooking

- QUICKSTART fast preheat system (left oven)
- Meat probe (left oven)
- 9 function (left) electric oven
- 4 function (right) electric oven
- Rotisserie for spit-roasting (right oven)
- Grill elements in both ovens
- Fully automatic programmer and minute minder (left oven)
- 2 x 5kW dual wok burners\*

### Energy rating

- A-rated

### Safety

- Thermostatically controlled fan to prevent fascia from overheating
- Oven lights for good visibility
- Triple-glazed to prevent doors from overheating
- Flame failure devices to shut off gas supply\*

### Cleaning

- Removable oven door and inner glass panel
- Stay-clean liners for oven sides and back (left oven)
- Stay-clean liners for oven sides (right oven)
- Removable enamelled roof trays
- Single piece pressed hob

### Other features

- Heavy duty shelves
- Wok support\*
- Soft close storage drawer
- Height adjustable legs
- One hand ignition
- Telescopic runners (left oven)

### Supplied with

#### Left oven

Two wire shelves, one grill pan with trivet and handle

#### Right oven

One wire shelf, one grill pan with trivet, rotisserie

### Dimensions

#### Cooker

(W) 995mm x (H) 890 - 915mm x (D) 600mm

#### Left oven internal

(W) 454mm x (H) 354mm x (D) 428mm  
(Gross: 69 litres, usable: 52 litres)

#### Right oven internal

(W) 354mm x (H) 354mm x (D) 428mm  
(Gross: 54 litres, usable: 42 litres)

## Optional accessories

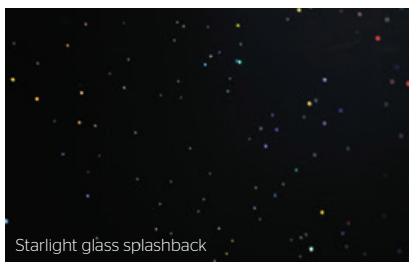

Starlight glass splashback

- Chef Top\*
- Cast iron griddle\*
- Splashback
- Plinth kit
- Telescopic runners

See pages 66-70 for more information

## Colour options



## Hob options

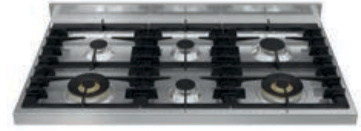

### Gas hotplate - six brass burners

Two dual wok burners 0.48 - 5kW each

One large burner 3kW

Three medium burners 1.75kW each

Convertible to LPG (bottled gas) if required

Dedicated cooker circuit with a 20 amp miniature circuit breaker

### Product codes

Gloss black RC-10TG-FL-K (544446277)

Gloss cream RC-10TG-FL-CR (544446276)

Stainless steel RC-10TG-FL-S (544446275)



### Induction - 5 zones

Front left zone 1100/1400 watts

Back left zone 1400/2000 watts

Central zone 2300/3000 watts

Front right zone 1100/1400 watts

Back right zone 2300/3000 watts

Dedicated cooker circuit with a 32/40 amp miniature circuit breaker

### Product codes

Gloss black RC-10TI-FL-K (544446280)

Gloss cream RC-10TI-FL-CR (544446279)

Stainless steel RC-10TI-FL-S (544446278)

## Recommended hood



### Latour

Available in stainless steel

See pages 54-59 for more information

\*Gas hob only

# Fleet 90cm twin



RC-9TG-FL-CR (544446282)



## Features

### Cooking

- QUICKSTART fast preheat system (left oven)
- Meat probe (left oven)
- 9 function (left) electric oven
- 4 function (right) electric oven
- Rotisserie for spit-roasting (right oven)
- Grill elements in both ovens
- Fully automatic programmer and minute minder (left oven)
- 5kW dual wok burner\*

### Energy rating

- A-rated

### Safety

- Thermostatically controlled fan to prevent fascia from overheating
- Oven lights for good visibility
- Triple-glazed to prevent doors from overheating
- Flame failure devices to shut off gas supply\*

### Cleaning

- Removable oven door and inner glass panel
- Stay-clean liners for oven sides and back (left oven)
- Stay-clean liners for oven sides (right oven)
- Removable enamelled roof trays
- Single piece pressed hob

### Other features

- Heavy duty shelves
- Wok support\*
- Soft close storage drawer
- Height adjustable legs
- One hand ignition
- Telescopic runners (left oven)

### Supplied with

**Left oven**  
Two wire shelves, one grill pan with trivet and handle

**Right oven**  
One wire shelf, one grill pan with trivet, rotisserie

### Dimensions

**Cooker**  
(W) 895mm x (H) 890 - 915mm x (D) 600mm

**Left oven internal**  
(W) 454mm x (H) 354mm x (D) 428mm  
(Gross: 69 litres, usable: 52 litres)

**Right oven internal**  
(W) 254mm x (H) 354mm x (D) 428mm  
(Gross: 38 litres, usable: 28 litres)

## Optional accessories



Plinth kit

- Chef Top\*
- Cast iron griddle\*
- Splashback
- Plinth kit
- Telescopic runners

See pages 66-70 for more information

## Colour options



## Hob options



### Gas hotplate - six brass burners

One dual wok burner	0.48 - 5kW
One large burner	3kW
Three medium burners	1.75kW each
One small burner	1kW

Convertible to LPG (bottled gas) if required  
Dedicated cooker circuit with a 20 amp miniature circuit breaker

### Product codes

Gloss black	RC-9TG-FL-K (544446283)
Gloss cream	RC-9TG-FL-CR (544446282)
Stainless steel	RC-9TG-FL-S (544446281)



### Induction - 5 zones

Front left zone	1100/1400 watts
Back left zone	1400/2000 watts
Central zone	2300/3000 watts
Front right zone	1100/1400 watts
Back right zone	2300/3000 watts

Dedicated cooker circuit with a 32/40 amp miniature circuit breaker

### Product codes

Gloss black	RC-9TI-FL-K (544446286)
Gloss cream	RC-9TI-FL-CR (544446285)
Stainless steel	RC-9TI-FL-S (544446284)

## Recommended hood



### Latour (2tone)

Available in matching colour  
See pages 54-59 for more information

\*Gas hob only

# Q Line



Life's a beach when you have the versatile Q Line at your disposal. Clean lines and a stainless steel or gloss black finish bring contemporary style to any kitchen while the nine function oven and wide range of cooking options make it easy to cook up all your family's favourites.



# Q Line 100cm XG



RC-10XGI-QL-K (544440079)



## Features

### Cooking

- QUICKSTART fast preheat system (left oven)
- 9 function (left) electric oven
- 4 function (right) electric oven
- Rotisserie for spit-roasting (right oven)
- Grill elements in both ovens
- Powerful adjustable grill in separate compartment
- Fully automatic programmer and minute minder (left oven)
- 2 x 5kW dual wok burners\*

### Energy rating

- A-rated

### Safety

- Thermostatically controlled fan to prevent fascia from overheating
- Oven lights for good visibility
- Triple-glazed to prevent doors from overheating
- Flame failure devices to shut off gas supply\*

### Cleaning

- Removable oven door and inner glass panel
- Removable enamelled roof trays
- Single piece pressed hob

### Other features

- Storage compartment
- Leveling feet
- One hand ignition
- Telescopic runners (grill compartment)

### Supplied with

#### Left oven

Two wire shelves, one grill pan with trivet and handle

#### Right oven

One wire shelf, one grill pan with trivet, rotisserie

#### Grill compartment

Full sized roll-out grill pan with trivet

### Dimensions

#### Cooker

(W) 995mm x (H) 910 - 915mm x (D) 600mm

#### Left oven internal

(W) 454mm x (H) 354mm x (D) 428mm  
(Gross: 69 litres, usable: 52 litres)

#### Right oven internal

(W) 354mm x (H) 354mm x (D) 428mm  
(Gross: 54 litres, usable: 42 litres)

## Optional accessories



- Chef Top\*
- Wok support\*
- Cast iron griddle\*
- Stay-clean liners
- Splashback
- Telescopic runners

See pages 66-70 for more information

## Colour options

Stainless steel

Gloss black

## Hob options

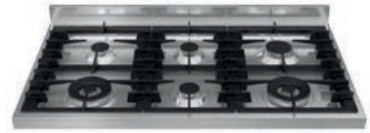

### Gas hotplate - six aluminium burners

Two dual wok burners 0.48 - 5kW each

One large burner 3kW

Three medium burners 1.75kW each

Convertible to LPG (bottled gas) if required

Dedicated cooker circuit with a 32 amp miniature circuit breaker

### Product codes

Stainless steel RC-10XGG-QL-S (544440158)

Gloss black RC-10XGG-QL-K (544440182)



### Induction - 5 zones

Front left zone 1100/1400 watts

Back left zone 1400/2000 watts

Central zone 2300/3000 watts

Front right zone 1100/1400 watts

Back right zone 2300/3000 watts

Dedicated cooker circuit with a 40 amp miniature circuit breaker

### Product codes

Stainless steel RC-10XGI-QL-S (544440196)

Gloss black RC-10XGI-QL-K (544440079)

## Recommended hood



### Omaggio

Available in black glass with stainless steel  
See pages 54-59 for more information

\*Gas hob only

# Q Line 100cm twin



RC-10TG-QL-S (544440040)





## Features

### Cooking

- QUICKSTART fast preheat system (left oven)
- 9 function (left) electric oven
- 4 function (right) electric oven
- Rotisserie for spit-roasting (right oven)
- Grill elements in both ovens
- Fully automatic programmer and minute minder (left oven)
- 2 x 5kW dual wok burners\*

### Energy rating

- A-rated

### Safety

- Thermostatically controlled fan to prevent fascia from overheating
- Oven lights for good visibility
- Triple-glazed to prevent doors from overheating
- Flame failure devices to shut off gas supply\*

### Cleaning

- Removable oven door and inner glass panel
- Removable enamelled roof trays
- Single piece pressed hob

### Other features

- Storage compartment
- Height adjustable legs
- One hand ignition

### Supplied with

#### Left oven

Two wire shelves, one grill pan with trivet and handle

#### Right oven

One wire shelf, one grill pan with trivet, rotisserie

### Dimensions

#### Cooker

(W) 995mm x (H) 890 - 915mm x (D) 600mm

#### Left oven internal

(W) 454mm x (H) 354mm x (D) 428mm  
(Gross: 69 litres, usable: 52 litres)

#### Right oven internal

(W) 354mm x (H) 354mm x (D) 428mm  
(Gross: 54 litres, usable: 42 litres)

## Optional accessories



Cast iron griddle

- Chef Top\*
- Wok support\*
- Cast iron griddle\*
- Stay-clean liners
- Splashback
- Plinth kit
- Telescopic runners

See pages 66-70 for more information

## Colour options

Stainless steel

Gloss black

## Hob options

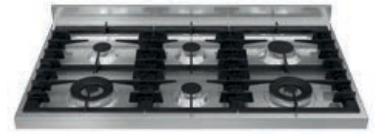

### Gas hotplate - six aluminium burners

Two dual wok burners 0.48 - 5kW each

One large burner 3kW

Three medium burners 1.75kW each

Convertible to LPG (bottled gas) if required

Dedicated cooker circuit with a 20 amp miniature circuit breaker

### Product codes

Stainless steel RC-10TG-QL-S (544440040)

Gloss black RC-10TG-QL-K (544440110)



### Induction - 5 zones

Front left zone 1100/1400 watts

Back left zone 1400/2000 watts

Central zone 2300/3000 watts

Front right zone 1100/1400 watts

Back right zone 2300/3000 watts

Dedicated cooker circuit with a 32/40 amp miniature circuit breaker

### Product codes

Stainless steel RC-10TI-QL-S (544440169)

Gloss black RC-10TI-QL-K (544440198)

## Recommended hood



### Arioso

Available in matching colour

See pages 54-59 for more information

\*Gas hob only

# Q Line 90cm twin



RC-9TG-QL-K (544440047)



## Features

### Cooking

- QUICKSTART fast preheat system (left oven)
- 9 function (left) electric oven
- 4 function (right) electric oven
- Rotisserie for spit-roasting (right oven)
- Grill elements in both ovens
- Fully automatic programmer and minute minder (left oven)
- 5kW dual wok burner\*

### Energy rating

- A-rated

### Safety

- Thermostatically controlled fan to prevent fascia from overheating
- Oven lights for good visibility
- Triple-glazed to prevent doors from overheating
- Flame failure devices to shut off gas supply\*

### Cleaning

- Removable oven door and inner glass panel
- Removable enamelled roof trays
- Single piece pressed hob

### Other features

- Storage compartment
- Height adjustable legs
- One hand ignition

### Supplied with

#### Left oven

Two wire shelves, one grill pan with trivet and handle

#### Right oven

One wire shelf, one grill pan with trivet, rotisserie

### Dimensions

#### Cooker

(W) 895mm x (H) 890 - 915mm x (D) 600mm

#### Left oven internal

(W) 454mm x (H) 354mm x (D) 428mm  
(Gross: 69 litres, usable: 52 litres)

#### Right oven internal

(W) 254mm x (H) 354mm x (D) 428mm  
(Gross: 38 litres, usable: 28 litres)

## Optional accessories



Telescopic runners

- Chef Top\*
- Wok support\*
- Cast iron griddle\*
- Stay-clean liners
- Splashback
- Plinth kit
- Telescopic runners

See pages 66-70 for more information

## Colour options

Stainless steel

Gloss black

## Hob options



### Gas hotplate - six aluminium burners

One dual wok burner	0.48 - 5kW
One large burner	3kW
Three medium burners	1.75kW each
One small burner	1kW

Convertible to LPG (bottled gas) if required

Dedicated cooker circuit with a 20 amp miniature circuit breaker

### Product codes

Stainless steel	RC-9TG-QL-S (544440098)
Gloss black	RC-9TG-QL-K (544440047)



### Induction - 5 zones

Front left zone	1100/1400 watts
Back left zone	1400/2000 watts
Central zone	2300/3000 watts
Front right zone	1100/1400 watts
Back right zone	2300/3000 watts

Dedicated cooker circuit with a 32/40 amp miniature circuit breaker

### Product codes

Stainless steel	RC-9TI-QL-S (544440200)
Gloss black	RC-9TI-QL-K (544440286)

## Recommended hood



### Briosio

Available in matching colour

See pages 54-59 for more information

\*Gas hob only

# Q Line 90cm single



RC-9SI-QL-S (544440165)



## Features

### Cooking

- QUICKSTART fast preheat system
- 9 function electric oven
- Grill element in oven
- Fully automatic programmer and minute minder
- 5kW dual wok burner\*

### Energy rating

- A-rated

### Safety

- Thermostatically controlled fan to prevent fascia from overheating
- Oven lights for good visibility
- Triple-glazed to prevent door from overheating
- Flame failure devices to shut off gas supply\*

### Cleaning

- Removable oven door and inner glass panel
- Removable enamelled roof tray
- Single piece pressed hob

### Other features

- Storage compartment
- Height adjustable legs
- One hand ignition

### Supplied with

#### Oven

Two wire shelves, one grill pan with trivet and handle

#### Dimensions

#### Cooker

(W) 895mm x (H) 890 - 915mm x (D) 600mm

#### Oven internal

(W) 678mm x (H) 354mm x (D) 428mm  
(Gross: 103 litres, usable: 80 litres)

## Optional accessories



Bake-O-Glide™ oven tray liner

- Chef Top\*
- Wok support\*
- Cast iron griddle\*
- Stay-clean liners
- Splashback
- Plinth kit
- Telescopic runners
- Bake-O-Glide™ oven tray liner

See pages 66-70 for more information

## Colour options

Stainless steel

Gloss black

## Hob options



### Gas hotplate - six aluminium burners

One dual wok burner	0.48 - 5kW
One large burner	3kW
Three medium burners	1.75kW each
One small burner	1kW

Convertible to LPG (bottled gas) if required

Dedicated cooker circuit with a 16 amp miniature circuit breaker

### Product codes

Stainless steel	RC-9SG-QL-S (544440225)
Gloss black	RC-9SG-QL-K (544440778)



### Induction - 5 zones

Front left zone	1100/1400 watts
Back left zone	1400/2000 watts
Central zone	2300/3000 watts
Front right zone	1100/1400 watts
Back right zone	2300/3000 watts

Dedicated cooker circuit with a 32 amp miniature circuit breaker

### Product codes

Stainless steel	RC-9SI-QL-S (544440165)
Gloss black	RC-9SI-QL-K (544440342)

## Recommended hood



### Arioso

Available in matching colour

See pages 54-59 for more information

\*Gas hob only

# Stanza

Take your first step with Stanza. A sleek, dual fuel model in two compact sizes, with a giant list of features. From Quickstart technology and 5kW wok burner to a fully automatic programme and minute minder. So you can enjoy Britannia quality, whatever your budget.





# Stanza 100cm twin



RC-10TG-ST-S (544446306)





## Features

### Cooking

- QUICKSTART fast preheat system (left oven)
- 9 function (left) electric oven
- 4 function (right) electric oven
- Grill elements in both ovens
- Fully automatic programmer and minute minder (left oven)
- 2 x 5kW dual wok burners

### Energy rating

- A-rated

### Safety

- Thermostatically controlled fan to prevent fascia from overheating
- Oven lights for good visibility
- Triple-glazed to prevent doors from overheating
- Flame failure devices to shut off gas supply

### Cleaning

- Removable oven door and inner glass panel
- Removable enamelled roof trays
- Single piece pressed hob

### Other features

- Height adjustable legs
- One hand ignition

### Supplied with

**Left oven**  
Two wire shelves, one grill pan with trivet and handle

**Right oven**  
One wire shelf, one grill pan with trivet

### Dimensions

**Cooker**  
(W) 995mm x (H) 890 - 915mm  
x (D) 600mm

**Left oven internal**  
(W) 454mm x (H) 354mm x (D) 428mm  
(Gross: 69 litres, usable: 52 litres)

**Right oven internal**  
(W) 354mm x (H) 354mm x (D) 428mm  
(Gross: 54 litres, usable: 42 litres)

## Optional accessories



- Chef Top
- Wok support
- Cast iron griddle
- Splashback
- Plinth kit
- Telescopic runners

See pages 66-70 for more information

## Colour options

Stainless steel

Gloss black

## Hob options



### Gas hotplate - six aluminium burners

Two dual wok burners 0.48 - 5kW each

One large burner 3kW

Three medium burners 1.75kW each

Convertible to LPG (bottled gas) if required

Dedicated cooker circuit with a 20 amp miniature circuit breaker

### Product codes

Stainless steel RC-10TG-ST-S (544446306)

Gloss black RC-10TG-ST-K (544446307)

## Recommended hood



### Arioso

Available in matching colour

See pages 54-59 for more information

# Stanza 90cm twin



RC-9TG-ST-K (544446305)



## Features

### Cooking

- QUICKSTART fast preheat system (left oven)
- 9 function (left) electric oven
- 4 function (right) electric oven
- Grill elements in both ovens
- Fully automatic programmer and minute minder (left oven)
- 5kW dual wok burner

### Energy rating

- A-rated

### Safety

- Thermostatically controlled fan to prevent fascia from overheating
- Oven lights for good visibility
- Triple-glazed to prevent doors from overheating
- Flame failure devices to shut off gas supply

### Cleaning

- Removable oven door and inner glass panel
- Removable enamelled roof trays
- Single piece pressed hob

### Other features

- Height adjustable legs
- One hand ignition

### Supplied with

#### Left oven

Two wire shelves, one grill pan with trivet and handle

#### Right oven

One wire shelf, one grill pan with trivet

### Dimensions

#### Cooker

(W) 895mm x (H) 890 - 915mm x (D) 600mm

#### Left oven internal

(W) 454mm x (H) 354mm x (D) 428mm  
(Gross: 69 litres, usable: 52 litres)

#### Right oven internal

(W) 254mm x (H) 354mm x (D) 428mm  
(Gross: 38 litres, usable: 28 litres)

## Hob options



### Gas hotplate - six aluminium burners

One dual wok burner	0.48 - 5kW
One large burner	3kW
Three medium burners	1.75kW each
One small burner	1kW

Convertible to LPG (bottled gas) if required

Dedicated cooker circuit with a 20 amp miniature circuit breaker

### Product codes

Stainless steel	RC-9TG-ST-S (544446304)
Gloss black	RC-9TG-ST-K (544446305)

## Optional accessories



Telescopic runners

- Chef Top
- Wok support
- Cast iron griddle
- Splashback
- Plinth kit
- Telescopic runners

See pages 66-70 for more information

## Colour options

Stainless steel

Gloss black

## Recommended hood



### Briosso

Available in matching colour

See pages 54-59 for more information



# Colourange

Helping you to make any meal a masterpiece, the Colourange lets you take inspiration from the world around you to create a unique cooker that's a true work of art. From a scrap of paper to your favourite dress, we can match any shade from anywhere; giving you a cooker that complements your life and style perfectly.



# Hoods





Everything flows with our fabulous collection of cooker hoods made to complement our range cookers in both style and performance. Available in a range of styles and colours, each one is designed to keep the air fresh and make your kitchen complete.

# Wall mounted hoods

## Advanced Sensor Control

### ASC

ASC hoods are fitted with a sensor that detects steam, vapours, smoke and odours generated by cooking. This makes the hood fully automatic and no manual intervention is required.

When the sensor no longer detects odours, steam or smoke the hood continues to operate for a further few minutes to ensure all residual odours have been eliminated before turning itself off.

#### Further features of ASC include:

- The sensitivity level of the ASC System can be easily adjusted to suit your personal needs
- The ASC System can temporarily be changed by hand
- The hood can be changed from ASC System to manual operation at the touch of a button

## Colour options

SS	Stainless steel
GB	Gloss black
GC	Gloss cream
GR SS	Gloss red / Stainless steel
GB SS	Gloss black / Stainless steel
GC SS	Gloss cream / Stainless steel

## Arioso

2 YEAR  
GUARANTEE

ASC



#### Designed for ducting out or recycling

- The intelligent ASC system
- Quick release dishwasher proof grease filter
- A convenient filter alarm that tells you when to clean the grease filters for ultimate efficiency
- 2 x halogen lamps 20 watts

#### When recycling you will require

- Recycling charcoal filter - HOOD-BE-AC-F11

#### When ducting out you will require

- Ducting outlet size 150mm (diameter)

Speed	1	2	3
Air capacity cubic metres per hour*	285	610	700
Noise level - dbA**	51	66	69

#### Energy efficiency class

C

Size	Code	Colour	Code	Colour
90cm	544440194	SS	544440161	GB
	544440329	GC		
100cm	544440029	SS	544440085	GB
	544440185	GC		
110cm	544440063	SS	544440167	GB
	544440278	GC		
120cm	544440038	SS	544440319	GB
	544440890	GC		

\*Performance data according to Standard EN61591. Free air delivery

\*\*Noise level according to Standard IEC60704-2-13 method. All noise level - dbA figures are tested on ducted hoods

See pages 72 and 73 for recommended hood ducting information



## Latour



### Designed for ducting out or recycling

- Quick release dishwasher proof grease filters
- 2 x halogen lamps 20 watts
- A convenient filter alarm that tells you when to clean the grease filters for ultimate efficiency
- Automatic switch-off can be set for 10 minutes

### When recycling you will require

- Recycling filter kit - CT-KIT (90cm/100cm/110cm x 2, 120cm x 3) charcoal filters are supplied with kit
- Replacement charcoal filter - W0424-KF3 (90cm/100cm/110cm x 2, 120cm x 3)

### When ducting out you will require

- Ducting outlet size 150mm (diameter)

Speed	1	2	3
Air capacity cubic metres per hour*	244.1	511	755.3
Noise level - dbA**	45	62	71

### Energy efficiency class

A

Size	Code	Colour
90cm	544440306	SS
100cm	544440078	SS
110cm	544440339	SS
120cm	544440139	SS

## Latour (2tone)



### Designed for ducting out or recycling

- Quick release dishwasher proof grease filters
- 2 x halogen lamps 20 watts
- A convenient filter alarm that tells you when to clean the grease filters for ultimate efficiency
- Automatic switch-off can be set for 10 minutes

### When recycling you will require

- Recycling filter kit - CT-KIT (90cm/100cm/110cm x 2, 120cm x 3) charcoal filters are supplied with kit
- Replacement charcoal filter - W0424-KF3 (90cm/100cm/110cm x 2, 120cm x 3)

### When ducting out you will require

- Ducting outlet size 150mm (diameter)

Speed	1	2	3
Air capacity cubic metres per hour*	244.1	511	755.3
Noise level - dbA**	45	62	71

### Energy efficiency class

A

Size	Code	Colour	Code	Colour
90cm	544440578	GB SS	544440317	GC SS
	544440883	GR SS		
100cm	544440354	GB SS	544440375	GC SS
	544440494	GR SS		
110cm	544440743	GB SS	544440806	GC SS
	544440865	GR SS		
120cm	544440759	GB SS	544440871	GC SS
	544440576	GR SS		

# Wall mounted hoods

## Omaggio



2 YEAR  
GUARANTEE

### Designed for ducting out or recycling

- Quick release dishwasher proof grease filter
- Convenient alarms that tell you when to clean the grease filters and when to replace the charcoal filters
- 5 x LED 15 watts

### When recycling you will require

- Recycling charcoal filter - R216005 x 1

### When ducting out you will require

- Ducting outlet size 150mm (diameter)

Speed	1	2	3
Air capacity cubic metres per hour*	258	553	886
Noise level - dbA**	46	63	72

### Energy efficiency class

A

Size	Code	Colour
90cm	544440129	GB SS
100cm	544440111	GB SS

## Brioso



2 YEAR  
GUARANTEE

### Designed for ducting out or recycling

- Quick release dishwasher proof grease filters
- 2 x 40 watts lights

### When recycling you will require

- Recycling charcoal filters - 190 x 2

### When ducting out you will require

- Ducting outlet size 150mm (diameter)

Speed	1	2
Air capacity cubic metres per hour*	355	545
Noise level - dbA**	45	64

### Energy efficiency class

D

Size	Code	Colour	Code	Colour
90cm	544440010	SS	544440011	GB
100cm	544440002	SS	544440048	GB

\*Performance data according to Standard EN61591. Free air delivery

\*\*Noise level according to Standard IEC60704-2-13 method. All noise level - dbA figures are tested on ducted hoods

See pages 72 and 73 for recommended hood ducting information

# Canopy hoods

## Intimo canopy

2 YEAR  
GUARANTEE

ASC



### Designed for ducting out or recycling

- The intelligent ASC System, see page 62
- Size: 70 x 28.5cm
- Cut out size: 67.6 x 26.1cm
- 2 x halogen lamps 20 watts
- Suitable for use with 90cm and 100cm range cookers

### When recycling you will require

- Recycling charcoal filters - HOOD-BE-AC-FILA

### When ducting out you will require

- Ducting outlet size 150mm (diameter)

Speed	1	2	3
Air capacity cubic metres per hour*	258	600	700
Noise level - dbA**	50	67	70

### Energy efficiency class

C

Size options	Code	Colour
70cm	544440004	SS

## Latour canopy (single motor)

2 YEAR  
GUARANTEE



### Designed for ducting out or recycling

- Quick release dishwasher proof grease filters
- 2 x halogen lamps 20 watts (115cm version has 3)
- A convenient filter alarm that tells you when to clean the grease filters for ultimate efficiency
- Automatic switch-off can be set for 10 minutes

### When recycling you will require

- Recycling filter kit - CT-KIT-C x 2, charcoal filters are supplied with kit
- Replacement charcoal filter - WO423-K4 x 2

### When ducting out you will require

- Ducting outlet size 150mm (diameter)

Speed	1	2	3
Air capacity cubic metres per hour*	237.5	507.4	771.5
Noise level - dbA**	44	62	71

### Energy efficiency class

A

Size options	Code	Colour
95cm	544440268	SS
115cm	544440137	SS

# Cooling & dishwashers



Keep it stylish in the kitchen, with our beautifully designed dishwasher and fabulous fridge-freezers, which are available in a choice of stunning colours to complement our oven range. This makes them the natural choice for adding a fresh look to your space.



# Montana

## What's inside

### Description

#### 1 Electronic ice and water dispenser with child lock

Dispenses crushed or cubed ice and chilled filtered water from the front of the fridge. A child lock can be activated to prevent children from using the ice and water dispenser.

#### 2 Built-in water filter

Located inside the fridge and very easy to replace. The water filter needs replacing every six months.

#### 3 Integrated ice maker

Automatically senses when more ice is needed, and draws on the filtered water supply as necessary. The ice maker can produce over 130 cubes in 24 hours – great when you're planning a party!

#### 4 Sweetspot shelf

Never run out of essentials... like ice cream! This \*\*star rated freezer shelf gives you that all-important extra storage and serves up delicious ready-to-eat ice cream.

#### 5 Humidity crispers

Special seals reduce air movement in the crisper drawer, allowing fruit and vegetables to stay fresh and crispy for longer by retaining moisture levels.

#### 6 ClimateKeeper air tower and MultiFlow air system

Delivers cold air on two levels, ensuring a consistent temperature and keeping your food fresh and tasty throughout the fridge. Sensors help maintain the temperature.

#### 7 Frost guard technology

Super freezes food before starting a defrost cycle and minimises the risk of freezer burn. A defrost cycle is run automatically and only when needed, ensuring fridge and freezer remain frost free.



FF-MONTANA-S (544440622)

## Colour options

Stainless steel	FF-MONTANA-S (544440622)
Gloss black	FF-MONTANA-B (544440621)
Gloss cream	FF-MONTANA-C (544440620)
Gloss red	FF-MONTANA-R (544440623)



## Information

### Environment

The Montana is A+ rated for energy efficiency. The doors have a stop position to allow for easy loading and unloading of food but, if left partially open, the doors will automatically close and seal. A door alarm can be activated which will sound if either door remains fully open for longer than three minutes - preventing unnecessary loss of cold air.

The digital temperature controls for the Montana are located on the water dispenser control panel on the outside of the fridge, so there is no need to open the door and lose cold air when adjusting the temperature.

To protect the environment all our fridge-freezers are also CFC/HCFC free.

### Space

Combining the latest in American refrigeration technology and lots of space, the Montana has a generous capacity of 23 cu.ft. That's around 2 cu.ft more than the average fridge freezer - the equivalent of approximately 110 soda cans!

### Features

- Generous capacity of 23 cu.ft  
Fridge: 15.87 cu.ft  
Freezer: 7.13 cu.ft
- A+ rating for energy efficiency
- Electronic ice and water dispenser with child lock
- Integrated ice maker
- Sweetspot shelf
- Built-in water filter
- Humidity crispers
- ClimateKeeper air tower
- Frost guard technology
- Door alarm

### Supplied with

Fridge:

- 3 slide-out spill-proof tempered glass shelves
- Sealed clear crisper and adjustable humidity crisper
- 2 adjustable and 2 standard door compartments and 1 dairy compartment

Freezer:

- 2 slide-out spill-proof tempered glass shelves
- 2 slide-out drawers
- 5 standard door compartments

## Dimensions

### Key

- A** Overall height
- B** Overall width
- C** Overall depth
- D** Depth with fridge door open at 90°
- E** Depth with freezer door open at 90°
- F** Clearance freezer door open
- G** Clearance fridge door open
- H** Depth excluding doors
- I** Depth excluding handles

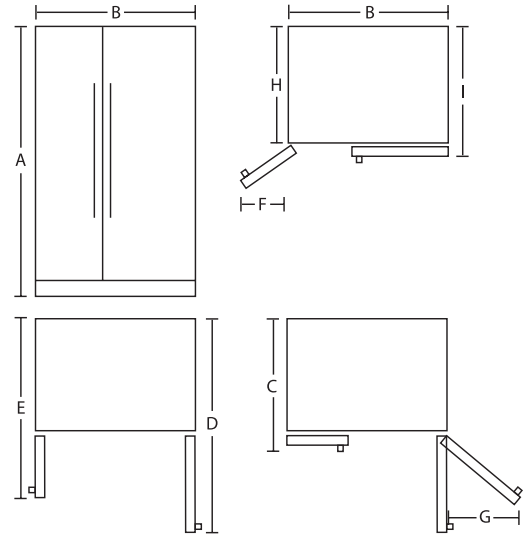

Total capacity	23 cu.ft (643 litres)
Capacity fridge	15.87 cu.ft (379 litres net)
Capacity freezer	7.13 cu.ft (170 litres net)
Overall height (A)	1805mm
Overall depth including handle (C)	746mm
Cabinet depth excluding doors (H)	610mm
Depth excluding door handles (I)	690mm
Depth with fridge door open 90° (D)	1168mm
Depth with freezer door open 90° (E)	1040mm
Overall width (B)	915mm
Clearance fridge door open (G)	460mm
Clearance freezer door open (F)	390mm
Air clearance - freestanding	5mm
Air clearance - built-in	25mm
Approximate shipping weight	172KG
Energy rating	A+
Energy consumption	448kWh/year
ISO temperature rise time	5.46hrs
Freezer star rating	4
Freezer capacity (Kg/42hrs)	12.0Kg/24hrs
Noise (dbA)	47

# Breeze



Breeze Retro Fridge Freezer

Gloss black	544446212
Vanilla	544446213
Chilli red	544446250

### Features

Frost free	Yes
Number of doors	2
Lighting	LED
Bottle shelf	1
Door shelf	3
Fridge drawers	2
Freezer drawers	3
Adjustable shelves	Yes
Adjustable door storage	Yes
Energy rating	A+
Freezer star rating	4

### Dimensions

Total capacity (gross)	335 ltr
Capacity fridge (net)	231 ltr
Capacity freezer (net)	87 ltr
Overall height	1899mm
Overall depth	670mm
Overall width	605mm



Breeze Retro Top Mount Fridge Freezer

Gloss black	544446215
Vanilla	544446216
Chilli red	544446251

### Features

Frost free	Static
Number of doors	2
Lighting	LED
Bottle shelf	1
Door shelf	3
Fridge drawers	1
Adjustable shelves	Yes
Energy rating	A+
Freezer star rating	4

### Dimensions

Total capacity (gross)	310 ltr
Capacity fridge (net)	241 ltr
Capacity freezer (net)	63 ltr
Overall height	1754mm
Overall depth	635mm
Overall width	605mm



Breeze Retro Fridge

Gloss black	544446218
Vanilla	544446219
Chilli red	544446252

### Features

Frost free	Static
Number of doors	1
Lighting	LED
Bottle shelf	1
Door shelf	4
Fridge drawers	1
Adjustable shelves	Yes
Ice box	Yes
Energy rating	A+
Freezer star rating	4

### Dimensions

Total capacity (gross)	323 ltr
Capacity fridge (net)	281 ltr
Capacity freezer (net)	30 ltr
Overall height	1769mm
Overall depth	635mm
Overall width	605mm



# Cascata



## 60cm Integrated Dishwasher

White 544446303

### Features

Number of place settings	14
Number of temperature levels	6
Digital display	LCD
Programme time remaining display	Yes
Delay timer	24
Drying type	Extra drying
Rinse aid refill indicator	Yes
Salt refill indicator	Yes
Adjustable upper basket	Yes
Overflow protection	Yes
Removable cutlery basket	No
Adjustable racking	Yes
Half load	No
Energy rating	A+++
Noise level (dB)	45

### Programmes

Number of programmes	8
Normal wash	Yes
Rinse and hold (one hour)	Yes
Intensive wash	Yes
Pre-rinse	No
Economy wash	Yes
Glass/delicate wash	Yes
Rapid/quick wash	Yes

### Dimensions

Overall height	815mm
Overall depth	598mm
Overall width	550mm

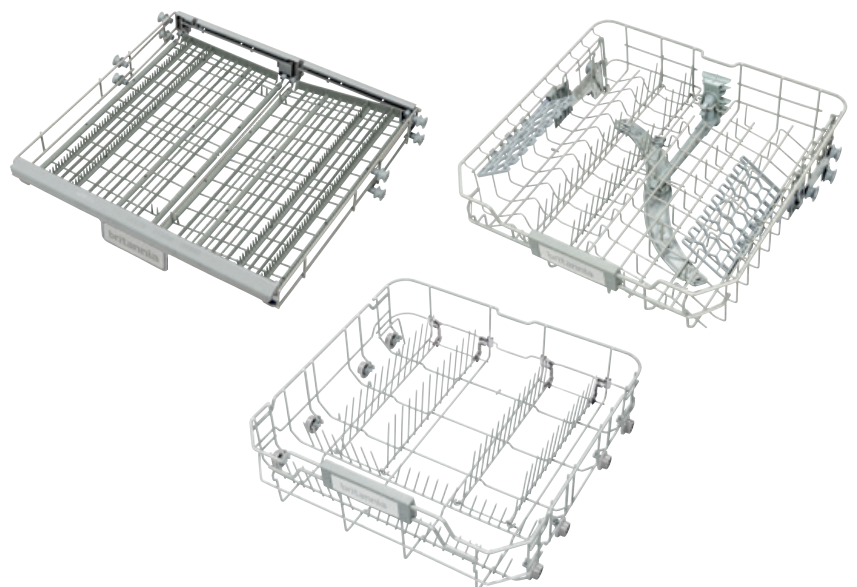

Dishwasher shown with furniture, for illustration purposes only.

# Splashbacks & accessories

From our range of attractive splashbacks to griddles, stay-clean oven liners and wok supports, Britannia brings you all the ingredients you need to enhance your cooking experience, make life easier and keep your range cooker looking its best.





# Accessories



## Chef Top

Britannia offers a healthy cooking option with the professional Chef Top centred around the Teppanyaki style of cooking. This fantastic feature not only helps the domestic gourmet revolutionise the entire cooking experience of creating a stir-fry, it is also fantastic for cooking breakfasts and a wealth of main courses.

The Chef Top is available for all Britannia range cookers. The 120cm Delphi and Fleet models also include an electric stainless steel griddle as standard. This can be used in the same way as the Chef Top.

Style	Order code
Chef Top	<b>BAC-CHEFTOP (544440719)</b>



## Griddle

This solid cast iron griddle simply sits on top of a standard pan support. It is ideal for griddling all types of food that would be traditionally grilled.

- Half of the griddle has a flat cooking surface and is ideal for cooking eggs, drop scones, Welsh cakes, etc.
- The other half of the griddle is ribbed and is ideally suited for searing meats.

Style	Order code
Cast iron griddle - half flat/half ribbed	<b>BAC-GRID (544440725)</b>

## Plinth kit

These three-sided kits (available in sizes from 90-120cm cooker widths) simply slide beneath your cooker to conceal the adjustable legs. Please note these cannot be used with the extra high legs and are not suitable for XG models.

Size	Order code
90cm Stainless steel	<b>(544446240)</b>
100cm Stainless steel	<b>(544446239)</b>
120cm Stainless steel	<b>(544446238)</b>

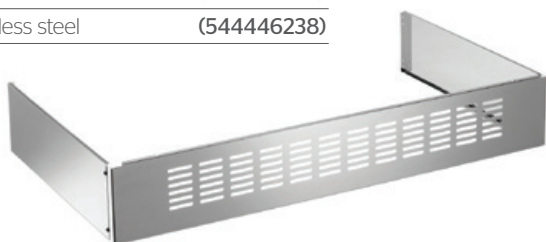

## Telescopic runners

Delphi and Fleet models include one pair of telescopic runners as standard, which can be used at any shelf level. Additional pairs can be purchased which are suitable for use in all Britannia ovens. Even when fully extended, the telescopic system is safe, providing a convenient way of serving directly from the grill pan or oven tray.

Telescopic runners are suitable for use in conjunction with the shelves and oven trays supplied as standard.

Style	Order code
Telescopic runners	<b>BAC-KGS-UN (544440710)</b>



## Extra high legs

All Britannia cookers (except for XG models) are supplied with four adjustable legs making the cooker fit with the majority of kitchen furniture heights. Extra high adjustable legs are available as an optional extra.

(Please note, plinth kits are not suitable for use with these extra high legs).

Item	Order code
Extra high legs	<b>BAC-LEGS (544446249)</b>



## Cast iron wok support

This useful accessory is simply placed over the pan support. The cast iron wok support can be used with round-bottomed woks and round-bottomed balti pans. In general, flat-bottomed woks will be stable on the pan support without this accessory.

Item	Order code
Cast iron wok support	BAC-WOK (544440707)



## Stay-clean oven liners

Stay-clean liners help keep your oven like new. Simply heat the oven to maximum temperature for 45 minutes from time to time.

Size	Order code
30cm	BAC-SCLBRIT30 (544440904)
40cm	BAC-SCLBRIT40 (544440726)
60cm	BAC-SCLBRIT60 (544440727)
90cm	BAC-SCLBRIT90 (544440728)

## Bake-O-Glide™ Chef Top liner

This liner has been exclusively designed by Bake-O-Glide™ for the Britannia Chef Top. The non-slip backing and easy to clean surface make cooking a pleasure, and help to keep your Chef Top looking pristine.



## Bake-O-Glide™ oven tray liners

Designed to perfectly fit the Britannia oven and grill trays, these liners make cleaning effortless. Use for everything from roast potatoes to pizzas and meringues for trouble-free cooking. Also ideal for use with the rotisserie. Available in sets for all range cooker sizes.

Size	Order code
Bake-O-Glide™ Chef Top liner	BAC-BAKE-C (544440709)
Bake-O-Glide™ 90cm single oven tray liner	BAC-BAKE-9S (544440716)
Bake-O-Glide™ 90cm twin oven tray liners	BAC-BAKE-9T (544440702)
Bake-O-Glide™ 100cm twin oven tray liners	BAC-BAKE-10 (544440711)
Bake-O-Glide™ 120cm twin oven tray liners	BAC-BAKE-12 (544440781)
Bake-O-Glide™ 100cm/110cm XG twin oven and grill tray liners	BAC-BAKE-XG (544440799)



## Cleaning consumables\*



Item	Order code
Hob cleaner	82648058
Stainless steel cleaner	82648059
Oven cleaner	82648060
Multi purpose kitchen cleaner	82648061
Fridge cleaner	82648062
Microwave cleaner	82648063
Freezer de-icer	82648064
Kettle descaler	82648065
Washing machine descaler	82648066
Dishwasher descaler	82648067

\*These products need to be ordered via our service department and maybe varied.

# Splashbacks

## Starlight



Material Type: **Glass**  
Glass Type: **Clear**

Style	Order code
90cm	544446036
100cm	544446037
110cm	544446038
120cm	544446039

## Prism silver glass

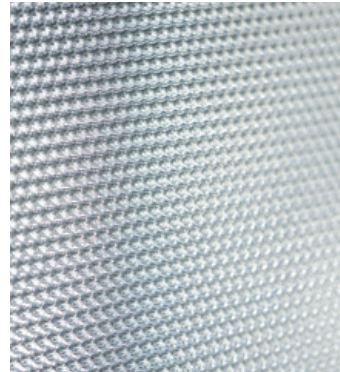

Material Type: **Glass**  
Glass Type: **Krizet**

Style	Order code
90cm	544446040
100cm	544446041
110cm	544446042
120cm	544446043

## Prism black glass



Material Type: **Glass**  
Glass Type: **Krizet**

Style	Order code
90cm	544446044
100cm	544446045
110cm	544446046
120cm	544446047

## Stainless steel with rail



Material Type: **Metal**  
Steel Type: **Stainless**  
Rail Type: **T-bar handle**

Style	Order code
90cm	544446048
100cm	544446049
110cm	544446050
120cm	544446051

## Stainless steel

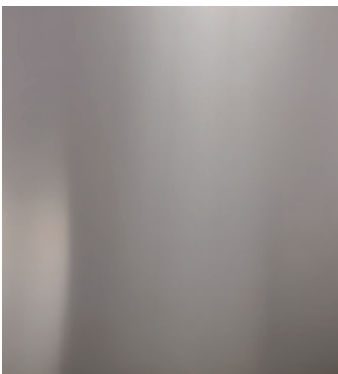

Material Type: **Metal**  
Steel Type: **Stainless**

Style	Order code
90cm	544446052
100cm	544446053
110cm	544446054
120cm	544446055

## Gloss black



Material Type: **Metal**  
Steel Type: **Black**

Style	Order code
90cm	544446056
100cm	544446057
110cm	544446058
120cm	544446059

## Decorative stainless steel

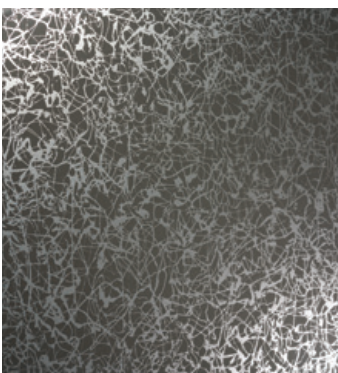

Material Type: **Metal**  
Steel Type: **Stainless**

Style	Order code
90cm	544446060
100cm	544446061

## Decorative black steel

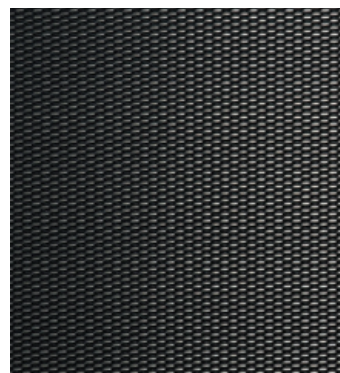

Material Type: **Metal**  
Steel Type: **Black**

Style	Order code
90cm	544446062
100cm	544446063

# Delivery and installation

Britannia employs dedicated delivery and installation teams to ensure our cookers get the professional attention they deserve.

## Pre-installation

Dual fuel cookers must be installed by a GAS safe registered engineer in accordance with gas safety regulations. The gas hotplate is manufactured for use with natural gas, but can be converted to LPG (bottled gas). Conversion to LPG can be completed by Britannia. Make sure your order clearly states that conversion to LPG is required.

Kitchen cabinets may be fitted flush to the sides of the cooker, but to allow for cleaning and servicing a 2.5mm gap is recommended on each side. For safety, the worktop or kitchen cabinets must not protrude beyond the height of the cooker hotplate frame.

For further information, call our experienced technical team on 0344 463 9705 (option 1).



All Britannia appliances are guaranteed for two years. Your Britannia retailer can give you full details. Please note that all guarantees and warranties relate to domestic installations only and not to commercial premises.

## Where to buy your Britannia

To ensure you receive the best service, we have appointed Britannia retailers throughout the UK and Ireland. Visit [www.britannialiving.co.uk/local-dealer](http://www.britannialiving.co.uk/local-dealer).

Britannia appointed retailers are selected carefully and undergo thorough product training to ensure they have the required expertise and knowledge.

## Delivery

Our delivery teams are experienced in transporting and handling range cookers. Range cookers are heavy and should be handled by at least two people. They should never be dragged by the oven handles as damage may occur.

## Aftersales service

A team of Britannia employed engineers is available throughout mainland UK to look after your cooker. Only our engineers will be able to supply you with genuine Britannia parts, ensuring you will enjoy many years of cooking on your Britannia.

As a Britannia owner you will find the Britannia website ([www.britannialiving.co.uk](http://www.britannialiving.co.uk)) a convenient and valuable source of information. You can find details on accessories, cooking and cleaning tips to enhance your cooking experience.

A Britannia cooker will give you many years of cooking pleasure. Should you unexpectedly experience a problem, you can access the Frequently Asked Questions page on our website, request an engineer or call 0344 463 9705 (option 1).

# Hood ducting information

## Hood fitted on an outside wall using 150mm diameter ducting

1 metre ducting kit - Duct 2609 (544440633) comprises of:

- A** One metre pipe - Duct/1100-6
- B** 90° bend - Duct/690
- C** Wall vent - Duct/6900

Always try to position your cooker and hood on an outside wall. This makes for the easiest installation. It also minimises the ducting run length and maximises the hood's performance.

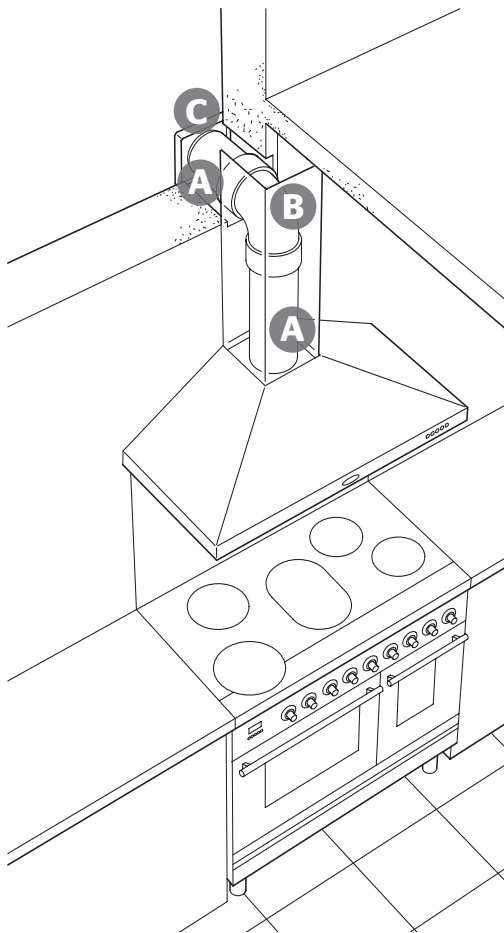

## Hood fitted on an inside wall to run across top of units

'Mega Duct' kit - Duct 2652B (544440675) comprises of:

- A** 150mm pipe (cut to size)
- B** Adjustable spigot 90° round\* to rectangular bend
- C** 1 metre flat of channel (can be cut to size)
- D** Flat channel connector
- E** Rectangular to round adaptor
- F** Wall plate
- G** Outside wall vent

\*The 90° bend should be fitted outside and above the flue of the chimney board. 'Mega Duct' can be boxed in to match kitchen and decorative flue sections.

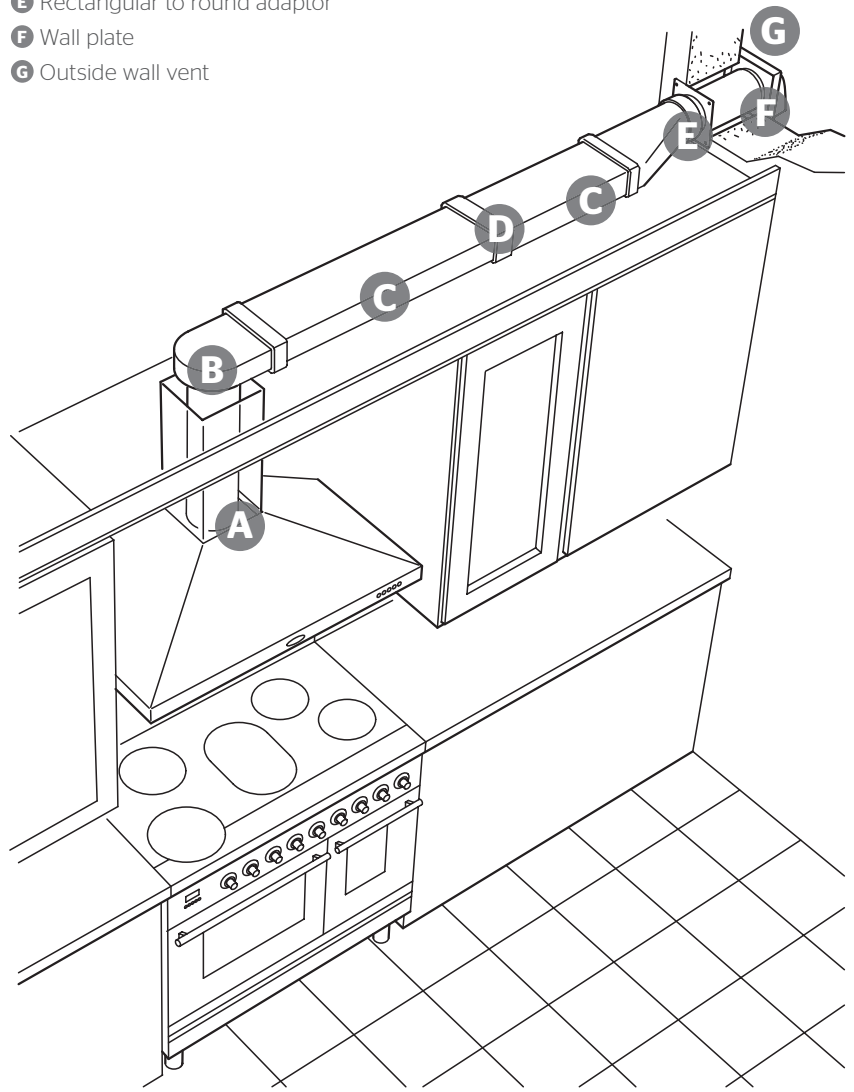



**Hood fitted on an inside wall using 150mm diameter ducting**

1 metre ducting kit - Duct 2609 (544440633) comprises of:

- A** One metre pipe - Duct/1100-6
- B** 90° bend - Duct/690
- C** Wall vent - Duct/6900

You will also need:

- D** Pipe connection - Duct/693 (544440639)
- E** 1 metre pipe - Duct/1100-6 (544440657) or  
2 metre pipe - Duct/1200 - 6 (544440640)

Sometimes this is the ideal solution for kitchens with a false ceiling or for use in a bungalow. If being used in a house, check you have enough space. Check the direction of joists. Do not cut holes through joists.

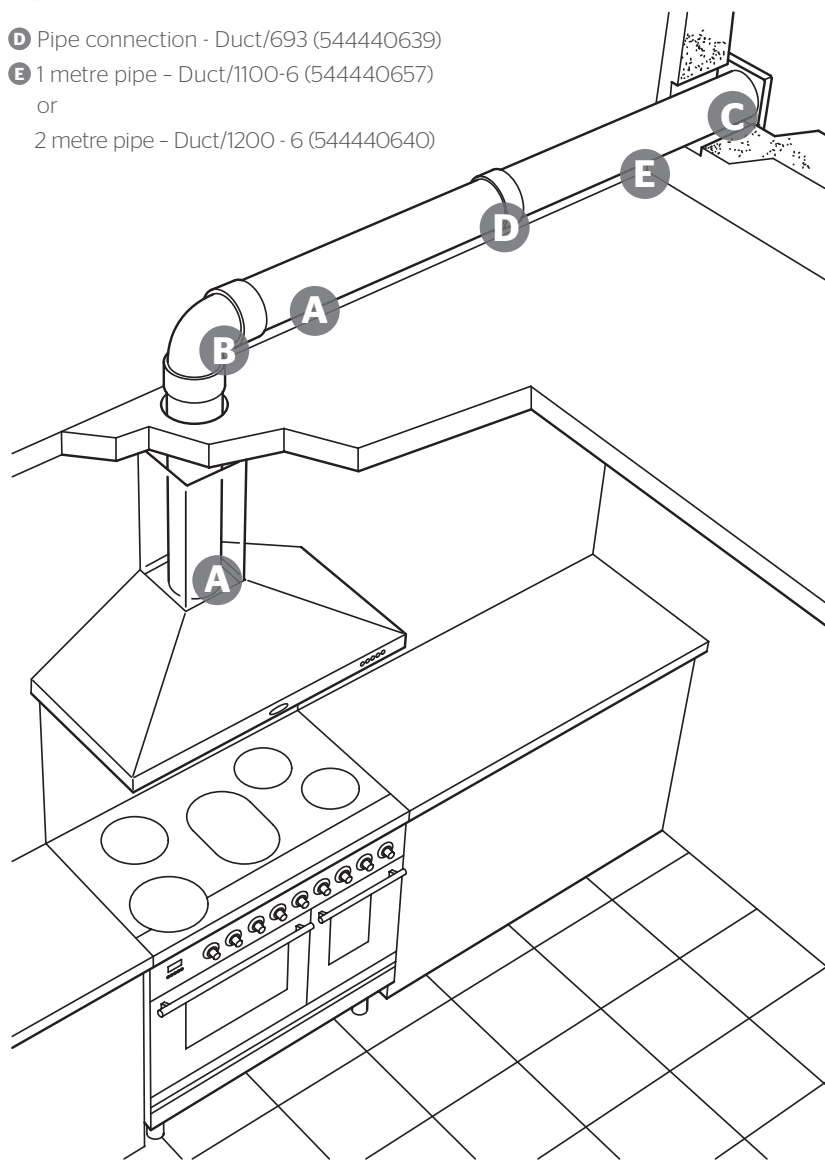

**1 metre pipe  
150mm diameter  
Duct/1100-6**

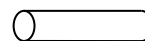

(544440657)

**2 metre pipe  
150mm diameter  
Duct/1200-6**

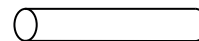

(544440640)

1 metre and two metre pipes can be cut to desired length.

**1 metre  
flat channel  
Duct/910**

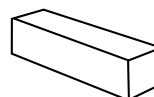

(544440644)

**90° bend  
150mm diameter  
Duct/690**

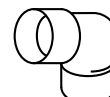

(544440650)

To obtain the best possible extraction performance use 150mm diameter ducting. Wherever possible utilise rigid circular pipe or 'Mega Duct' ducting - both types are available via your Britannia dealer. Where possible, do not use expanding concertina type ducting as this is not smooth on the interior and can cause air flow restrictions. Do not use ducting that has a smaller diameter than 150mm as this will reduce extraction rates and can increase noise levels.

**Horizontal  
bend duct/950**

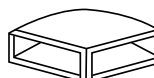

(544440685)

**Wall vent  
with gravity flaps  
duct/6900**

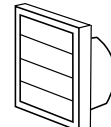

(544440663)

**Pipe connector  
duct/693**



(544440639)

**Flat channel  
connector duct/920**

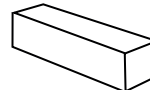

(544440645)

**'Mega Duct' kit  
duct 2652B  
(544440675)**

Product may vary from illustration shown

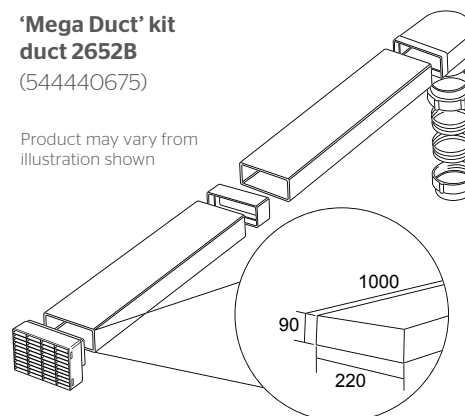

**Please note ducting kits and ducting components are optional accessories and have to be ordered - they are not supplied with the hood.**

# Range cooker

**120cm**

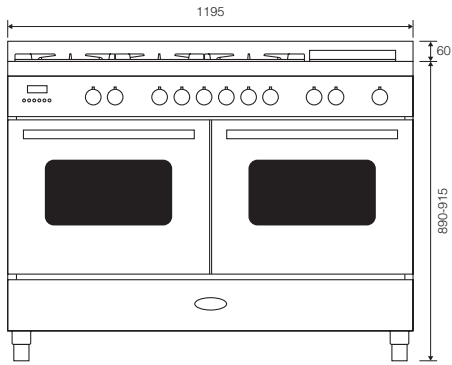

Front 60/60 split ovens

**110cm XG\***

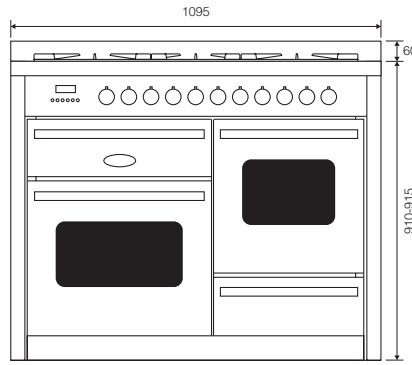

Front 60/40 split ovens

**100cm XG\***

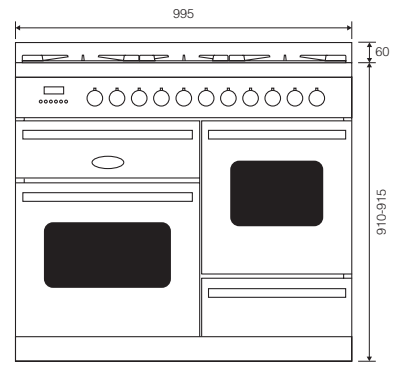

Front 60/40 split ovens

**100cm**

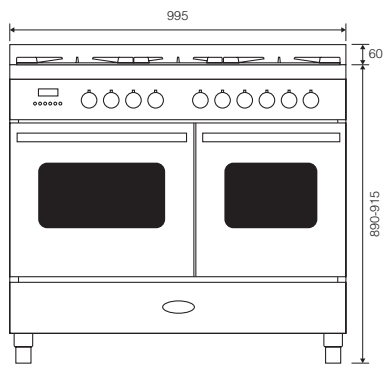

Front 60/40 twin ovens

**90cm**

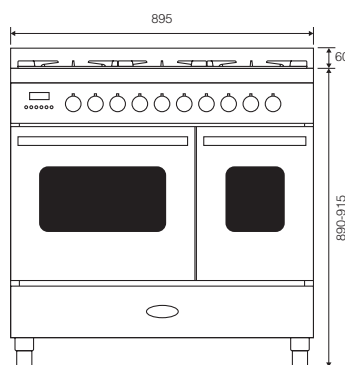

Front 60/30 twin ovens

**90cm**

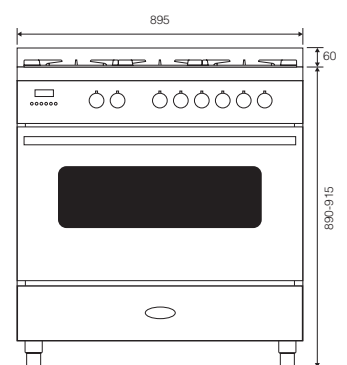

Front single oven

**60cm**

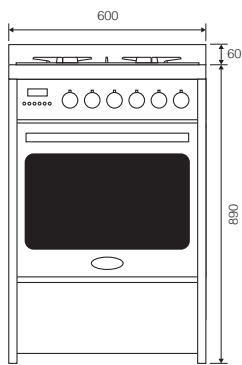

Front single oven

**Sides**

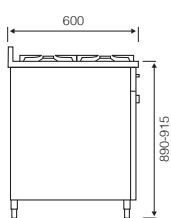

Side

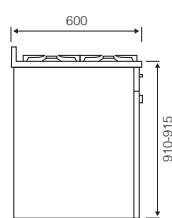

\*Side XG

# Dishwasher

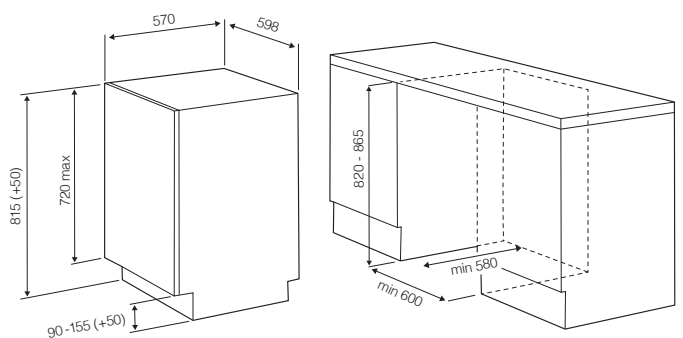

# Hoods

**Arioso**

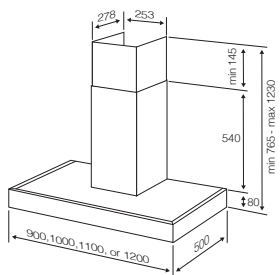

**Latour**

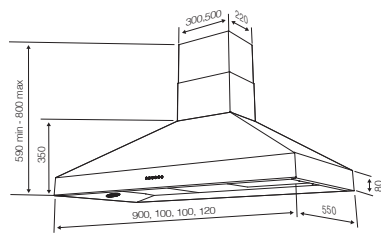

**Latour (2tone)**

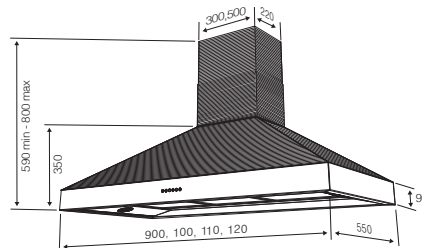

**Omaggio**

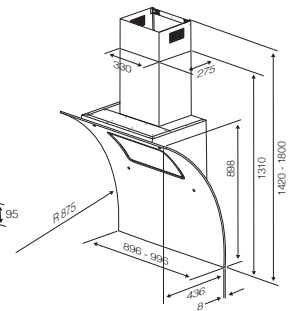

**Brioso**

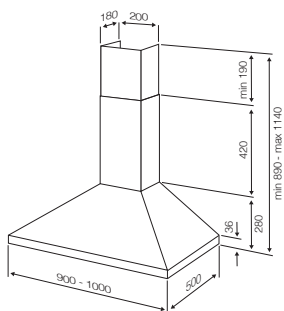

**Intimo**

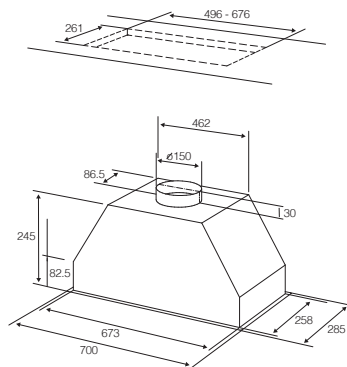

**Latour (Single Motor)**

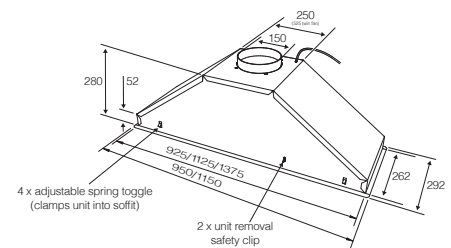

# Cooling

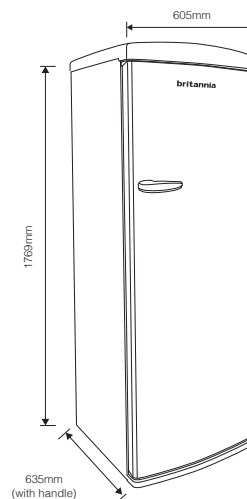
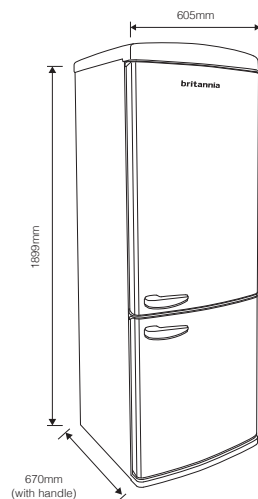
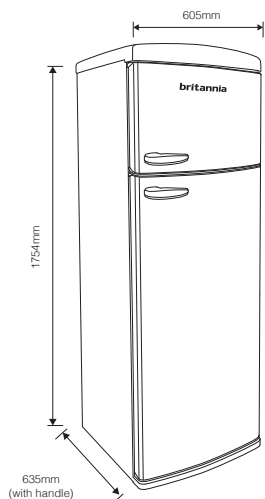

[www.britannialiving.co.uk](http://www.britannialiving.co.uk)

 [facebook.com/Britannia.Living](https://facebook.com/Britannia.Living)

 [@BritanniaLiving](https://twitter.com/BritanniaLiving)

 [Britannialiving](https://www.youtube.com/Britannialiving)

**Britannia Living**

Glen Dimplex Home Appliances  
Eastern Rise, Trentham Lakes,  
Stoke-on-Trent.

Staffordshire ST4 8WG

**Tel 0344 463 9705**

**[www.britannialiving.co.uk](http://www.britannialiving.co.uk)**

**Sales, Administration and Finance**

**Britannia Living**

Glen Dimplex Home Appliances  
Stoney Lane, Prescott,  
Merseyside L35 2XW

**Tel 0344 463 9705**

**Email [enquiry@britannialiving.co.uk](mailto:enquiry@britannialiving.co.uk)**

**Britannia is exclusively supplied throughout Ireland by Glen Dimplex Northern Ireland and Dimpco.**

Republic of Ireland: Contact Dimpco on +353 (0) 1842 4833 or email: [sales@dimpco.ie](mailto:sales@dimpco.ie)

Northern Ireland: Contact Glen Dimplex Northern Ireland on (028) 3833 7317 or email: [sales@glendimplexni.co.uk](mailto:sales@glendimplexni.co.uk)